



IP Office

4620, 4621, 4625, 5620 and 5621
Phone User Guide

Notice

While reasonable efforts were made to ensure that the information in this document was complete and accurate at the time of printing, Avaya Inc. can assume no liability for any errors. Changes and corrections to the information in this document may be incorporated in future releases.

Documentation Disclaimer

Avaya Inc. is not responsible for any modifications, additions, or deletions to the original published version of this documentation unless such modifications, additions, or deletions were performed by Avaya.

Link Disclaimer

Avaya Inc. is not responsible for the contents or reliability of any linked Web sites referenced elsewhere within this Documentation, and Avaya does not necessarily endorse the products, services, or information described or offered within them. We cannot guarantee that these links will work all of the time and we have no control over the availability of the linked pages.

License

USE OR INSTALLATION OF THE PRODUCT INDICATES THE END USER'S ACCEPTANCE OF THE TERMS SET FORTH HEREIN AND THE GENERAL LICENSE TERMS AVAILABLE ON THE AVAYA WEBSITE AT <http://support.avaya.com/LicenseInfo/> ("GENERAL LICENSE TERMS"). IF YOU DO NOT WISH TO BE BOUND BY THESE TERMS, YOU MUST RETURN THE PRODUCT(S) TO THE POINT OF PURCHASE WITHIN TEN (10) DAYS OF DELIVERY FOR A REFUND OR CREDIT.

Avaya grants End User a license within the scope of the license types described below. The applicable number of licenses and units of capacity for which the license is granted will be one (1), unless a different number of licenses or units of capacity is specified in the Documentation or other materials available to End User. "Designated Processor" means a single stand-alone computing device. "Server" means a Designated Processor that hosts a software application to be accessed by multiple users. "Software" means the computer programs in object code, originally licensed by Avaya and ultimately utilized by End User, whether as stand-alone Products or pre-installed on Hardware. "Hardware" means the standard hardware Products, originally sold by Avaya and ultimately utilized by End User.

License Type(s): Designated System(s) License (DS).

End User may install and use each copy of the Software on only one Designated Processor, unless a different number of Designated Processors is indicated in the Documentation or other materials available to End User. Avaya may require the Designated Processor(s) to be identified by type, serial number, feature key, location or other specific designation, or to be provided by End User to Avaya through electronic means established by Avaya specifically for this purpose.

Copyright

Except where expressly stated otherwise, the Product is protected by copyright and other laws respecting proprietary rights. Unauthorized reproduction, transfer, and or use can be a criminal, as well as a civil, offense under the applicable law.

Third-Party Components

Certain software programs or portions thereof included in the Product may contain software distributed under third party agreements ("Third Party Components"), which may contain terms that expand or limit rights to use certain portions of the Product ("Third Party Terms"). Information identifying Third Party Components and the Third Party Terms that apply to them is available on Avaya's web site at: <http://support.avaya.com/ThirdPartyLicense/>

Avaya Fraud Intervention

If you suspect that you are being victimized by toll fraud and you need technical assistance or support, call Technical Service Center Toll Fraud Intervention Hotline at +1-800-643-2353 for the United States and Canada. Suspected security vulnerabilities with Avaya Products should be reported to Avaya by sending mail to: securityalerts@avaya.com. For additional support telephone numbers, see the Avaya Support web site (<http://www.avaya.com/support>).

Trademarks

Avaya and the Avaya logo are registered trademarks of Avaya Inc. in the United States of America and other jurisdictions. Unless otherwise provided in this document, marks identified by "®," "TM" and "SM" are registered marks, trademarks and service marks, respectively, of Avaya Inc. All other trademarks are the property of their respective owners.

Documentation information

For the most current versions of documentation, go to the Avaya Support web site (<http://www.avaya.com/support>) or the IP Office Knowledge Base (<http://marketingtools.avaya.com/knowledgebase/>).

Avaya Support

Avaya provides a telephone number for you to use to report problems or to ask questions about your contact center. The support telephone number is 1 800 628 2888 in the United States. For additional support telephone numbers, see the Avaya Web site: <http://www.avaya.com/support>.

Contents

1. The Telephone

1.1 Call Appearance Keys.....	9
1.2 Call Appearance Keys Icons.....	10
1.3 The Display.....	10
1.4 Logging On.....	11
1.5 Logging Off.....	11
1.6 No User	12

2. Basic Call Handling

2.1 Answering Calls.....	14
2.2 Making a Call.....	15
2.3 Clearing a Call.....	15
2.4 Headset Working.....	16
2.5 Speakerphone.....	17
2.6 Mute	17
2.7 Hold	17
2.8 Speed Dial.....	18
2.9 Redial	18
2.10 Transfer	18
2.11 Conference.....	19
2.12 Parking Calls.....	20
2.13 Private Call.....	20

3. Speed Dials

3.1 Dialling a Speed Dial Number.....	23
3.2 Adding a Speed Dial from the Call Log.....	23
3.3 Editing a Speed Dial.....	23
3.4 Deleting a Speed Dial.....	23
3.5 Adding a New Speed Dial.....	24

4. Using the Call Log

4.1 Accessing Call Logs.....	27
4.2 Displaying an Individual Log Entry.....	27
4.3 Making Calls from the Call Log.....	28
4.4 Turning a Log Entry into a Speed Dial.....	28
4.5 Deleting an Individual Log Entry.....	28
4.6 Deleting all Entries from a Log.....	28
4.7 Exiting the Call Log.....	28
4.8 Disabling the Call Log.....	28

5. Visual Voice

5.1 Listen to Voicemails.....	31
5.2 Changing Your Greeting.....	32
5.3 Send a Voicemail.....	33
5.4 Email Alerts.....	33
5.5 Changing Your Mailbox Password.....	34
5.6 Voicemail Transfer.....	34

6. Changing Options

6.1 Personal Ringing Options.....	36
6.2 Viewing IP Settings.....	36
6.3 Contrast Control.....	37
6.4 Reinstating the Phone.....	37
6.5 Changing Key Labels.....	38
6.6 Displaying Language Selection.....	39
6.7 Phone Screen on Answer.....	40

6.8 Phone Screen on Calling.....	40
6.9 Displaying Call Timers.....	41
6.10 Message Display Rate.....	41
6.11 Call Appearance Width.....	41
6.12 Visual Alerting.....	41

7. Function Keys

7.1 Function Key Programming.....	45
7.2 Shorthand Programming Mode.....	47
7.3 Longhand Programming Mode.....	48

8. System Features

8.1 Ring Back	50
8.2 Call Waiting.....	50
8.3 Call Forwarding.....	50
8.4 Diverting Calls.....	51
8.5 Do Not Disturb.....	52
8.6 Voicemail	52
8.7 Default Short Codes.....	53

9. Web Browsing

9.1 Accessing External WAP Websites.....	57
9.2 Web Navigation Controls.....	57
9.3 Entering Data.....	58

10. Management and Troubleshooting

10.1 Testing the Phone's Lights and Display.....	60
10.2 Troubleshooting Chart.....	61
Index	63

Chapter 1.

The Telephone

1. The Telephone

This guide covers the use of the 4620, 4621, 4625, 5620 and 5621 phones on IP Office phone system. These phones are physically similar. The key difference is that the 5620 and 5621 are only supported on the IP Office whereas the 4620, 4621 and 4625 are supported on a range of Avaya phone systems.

The diagram below shows the main phone features:



1. Display and Feature Buttons:

The Call Appearance Keys enable you to handle multiple calls with the display showing call information. There are 2 pages in the display; giving up to 24 system features that can be allocated to the function keys. See [Call Appearance Keys](#)^[94] and [Overview](#)^[44]. The information displayed varies according to the active feature.

- The display of the 4621 and 5621 phones have a backlight, while the display of the 4625 has a color backlight with built in standby mode. When in standby, lifting the handset or pressing **PHONE/EXIT** will re-activate the display.

2. Message Waiting Lamp: This lamp is used as follows:

- On (Continuous):** There are new messages in your voicemail mailbox, or in another mailbox for which you have been configured to receive "Message Waiting Indication".
- Flashing:** The lamp can also be set to flash when the phone receives a call. See [Visual Alerting](#)^[41].





3. Page Right/Left:

Shifts from one page to another in the same application when the display presents the paging indicator (↔). These buttons have no effect when the paging indicator is not displayed.

4. Options:

Displays the Options main screen, from which display and application settings can be updated.

5. Call Handling Buttons:

-  **HOLD:** Red button used to place a call on hold.
-  **TRANSFER:** Transfers a call to another phone.
-  **CONFERENCE:** Sets up conference calls with more than one other person.
-  **DROP:** Drops the current call or, if on a conference call, drops the last person to join the conference.
-  **REDIAL:** Redials the last number dialed or displays the last 6 numbers dialed from the phone, depending on configuration via the Options menu.

6. Numeric (dialling) Pad:

Standard 12 button pad for dialling phone numbers.

7. Volume Controls:

Adjusts the handset, speaker, headset, or ringer volume, depending on which item is in use. As you increase or decrease the volume, the top display area provides either a speaker, headset, handset, or ringer icon to indicate for which item you are adjusting volume, followed by a visual "volume meter" showing the volume level. These buttons also control the volume of the key click sounds made when you press fixed buttons on the phone, such as the dial pad or softkeys.

8. MUTE and LED Indicator:

Turns off the active SPEAKER, handset, or headset microphone to prevent the other person from hearing you. The associated LED lights steadily when the handset or headset is muted.

9. HEADSET and LED Indicator:

With a headset connected, changes audio control from the handset or speaker to the headset. The associated LED lights steadily when the headset is active. The headset jack socket is located on the base of the phone underneath the front edge.

10. SPEAKER and LED Indicator:

Accesses the SPEAKER feature. The associated LED lights steadily when the SPEAKER is active. The handset is muted while the speaker or headset is in use.

11. PHONE/EXIT:

Displays the phone application main screen or, if applicable, exits the current IP Office based feature, such as Speed Dial or Call Log, and normalizes the display.

12. Softkeys:

Used to navigate to or initiate certain features, such as Speed Dial or Call Log, as well as control certain actions within the features. These keys correspond to the text prompts in the display screen immediately above them.

1.1 Call Appearance Keys

There are four pages of call appearance and function keys. You can search through these by pressing ◀ and ▶. At default, first page of the main call screen contains three keys set as 'call appearance' keys. With these keys the phone is a multi-line phone, indicated as **a=**, **b=** and **c=**. The remaining 21 Function Keys can have system features allocated to them, by your system administrator, that are specific to your requirements (see [Function Keys](#)^[44]).

Your system administrator can allocate a call appearance key with:

- **A Bridged Appearance**
A bridged appearance key matches the status and operation of the call appearance key on a pre-defined colleague's phone. Hence, you can pick-up, make and receive calls on behalf of your colleague.
- **A Line Appearance**
An IP Office exchange line (but not IP lines) can be allocated to you such that the status of that line is displayed and you can use the line appearance key to make and receive calls.
- **Call Coverage Appearance**
A call coverage appearance key alerts you when a pre-defined colleague is receiving a call. The covered user does not need to be using call appearance keys. Hence, you can pick-up calls on behalf of your colleague.
- **System Features**
System Features, such as Abbreviated Dial (that automatically dials a frequently used number) can be set against key and/or dial pad digits. See [Function Keys](#)^[44].

Having more than two call appearance keys is very useful. When holding a call, you can answer or make another call and then switch between calls, transfer or conference. If you are set to receive call waiting indication, the waiting call is shown against the next call appearance key.

Note

- If your phone is operating in single line mode, call appearance keys are not available.













Caution

- Although the system administrator can replace the call appearance keys with Bridged, Line and Call Coverage Appearance keys, this would severely restrict the use of features such as conference and transfer.

It is for this reason that it is **strongly recommended** that all call appearance keys **remain at their default settings**.

1.2 Call Appearance Keys Icons

The icons displayed against the Call Appearance/Feature Keys allow you to determine the status (for example, on HOLD) of each call. Icons also indicate whether a feature has been activated for a particular button.

- **Incoming Call:** 
A  symbol next to a call appearance key indicates an incoming call. To answer the call and put any other current call on hold, press the adjacent  .
- **Connected:** 
A  symbol next to a call appearance key indicates that it is the currently connected call. The caller's phone number (if available) is also shown. To put the call on hold, press the adjacent  . An **H** is displayed.
- **On HOLD:** 
A  symbol next to a call appearance key indicates a call on hold. To take the call off hold and put any other current call on hold, press the adjacent  .
- **Function Active:** 
The button to the left or right of the function key is active.

1.3 The Display

- B Phone Locked:**
Internal calls only.
- D Call Forwarding On:**
See [Call Forwarding](#) ^[50].
- G In Group:**
You can enable/disable group membership.
- H Held Call:**
Shows the number of held calls. See [HOLD](#) ^[17].
- N Do Not Disturb On:**
See [Do Not Disturb](#) ^[52].
- NoUser No User:**
The extension is not currently logged on. see [No User](#) ^[12]
- O Out of Hours:**
This is displayed if one or more Hunt Groups is in "Out-of-Hours" mode.
- P Parked Calls:**
Shows the number of parked calls.
- T Twinned:**
The phone is being used as the twin of another phone.
- DISC Disconnected:**
To end the call, press  **SPEAKER**.
- CONN Connected:**
You are on a call.
- CONF CONFERENCE Call:**
You are part of a conference call, displayed on the left hand side of the display. See [CONFERENCE Calls](#) ^[19].
- ssss Suppressed Code:**
When an account code is entered, the number you enter is displayed as "ssss" for security purposes.

1.4 Logging On

Your administrator has created your initial configuration so that you will be automatically logged on to your home extension. However, you may be required to log in for the following reasons:

- Forced login - if your configuration does not allow automatic login to your home extension.
- To use an extension other than your own (hot desking)
- If you, or somebody else, has logged you out of your extension.

Notes

- When hot desking, any short codes you have setup on your home extension will be passed to the extension you have logged on to.
- Certain information such as speed-dials and call log are telephone model dependent, and will not be passed to the new extension.
- You will be able to hot desk to extensions on remote sites only if the Small Community Advanced Networking License is installed on that system.

To login to your home extension (forced login), enter ***35*P#**, where **'P'** is your login code.

To login at another extension (hot desking), enter ***35*N*P#**, where **'N'** is your home extension number and **'P'** is your login code.

Notes

- Your login code, if configured, will be supplied by your Administrator.
- You have 4 attempts at logging on. If you fail to logon correctly, the message "Invalid" will be shown on the main display and you will hear the busy tone. If you fail all 4 attempts to log on, you must wait 90 seconds before any login will be accepted, whether correct or not.

1.5 Logging Off

If you have been allocated a login code, you can log your phone off to prevent unauthorized use during an absence, or for privacy purposes.

If you are logging off from another extension, the system will log you back in at your home extension, unless the force-login option is set.

Caution

- Call Log entries and certain Speed Dial settings will remain on the extension even once you are logged out.

To **log off** the phone where you had logged on dial ***36**.

1.6 No User

The NoUser configuration will be used for extensions where the home user is not currently logged on for example:

- The home user is logged on to another extension
- Forced login is enabled

An extension set as NoUser will display the name "**NoUser**" and the extension number line will be blank or not-available.

If required, and you have been allocated a login code, you can logon using your extension number and login code. (see [Logging On](#)⁽¹¹⁾)

Note

- Although calls may be made from an extension marked **NoUser**, normally calls cannot be received on that extension.

Chapter 2.

Basic Call Handling

2. Basic Call Handling

2.1 Answering Calls

When a call arrives at your phone, you hear a ringing tone and a blinking bell icon appears on the associated call appearance.

To answer an incoming call at your extension:

Do one of the following:

- If you are not active on another call, answer the call using your handset, headset or speakerphone (see [Speakerphone](#) ^[17]).

or

- If you are active on a call already, place the active call on hold (see [Hold](#) ^[17]), and then answer the incoming call.

or

- If the call appearance for the ringing call is not displayed on the current screen page, press  **EXIT** to return to the first page of the Home screen. When you locate the call appearance for the ringing call, press the corresponding call appearance button.

Notes

- To redirect an incoming call, press  **Drop** to redirect the call to Forward On No Answer (if set) or voicemail (if available).
- If your phone rings for any longer than a specified period (15 seconds in default), any re-direction feature that you have activated, such as voicemail or call forwarding, will come into effect.

To answer a call at another extension:

You can answer from your own phone by using Call Pick-Up; lift your handset and dial:

- ***30** to answer a call ringing anywhere.
- ***31** to answer a call within your group.
- ***32*201#** to answer the call for a particular extension, in this example 201.

The default ring cadences are:

- **Internal calls** - single ring cadence.
- **External calls** - double ring cadence.

These can be changed by your system administrator.

2.2 Making a Call

There are several options for making a phone call, depending on what how you want to use the phone.

To make a call using the handset:

1. Pick up the handset.
2. Dial the phone number of the person you want to contact, including any outside line digits and/or area codes.

To make a call using speakerphone:

1. Press  **SPEAKER**.
2. Dial the phone number of the person you want to contact, including any outside line digits and/or area codes. See [SPEAKERphone](#) ¹⁷ for more information on using the speakerphone.

To make a call using speed dial:

- See [Speed Dials](#) ¹⁸.

2.3 Clearing a Call

To clear an established call:

Either:

- Replace the handset.
- Press  **DROP**.



2.4 Headset Working

When a headset is to be used, it must be plugged in to the headset socket on the base of the phone. To activate the headset and switch off the handset, press  **HEADSET**. The lamp beside the button is illuminated when headset working is activated.

To answer an incoming call:

- Press  **HEADSET**.

If you are already on a call:

- Place the first call on hold
- Press  next to the flashing bell icon ().

To clear a headset call:

- Press  **DROP**.



To manually make a call:

- Press  **HEADSET**.
- Dial the number. Remember to include the required access code (for example; 9 for an outside line) and listen to the progress of the call.

To automatically make a call:

- Press  **HEADSET**.

Do any of the following:



- Press  **REDIAL** and then press  to have the phone dial the last number that you dialed. See [Redial](#) ^[18].
- Access the Call Log and initiate a call to a specific entry. See [Making Calls from the Call Log](#) ^[28].
- Access the Speed Dial List in your personal directory and initiate a call to a specific entry. See [Dialling a Speed Dial Number](#) ^[23].

When the call is answered, speak to the called party.

2.5 Speakerphone

The two-way built-in speakerphone allows you to make and answer calls without lifting the handset. Keep in mind that two-way speakerphones may not operate satisfactorily in every environment (such as in very noisy locations).

To use the speakerphone with any feature:

1. Press  **SPEAKER**.
2. Make or answer the call, or access the selected feature.
3. Adjust the speakerphone volume if necessary. To adjust the volume, press  and . The eight volume levels are displayed.

To change from speakerphone to handset:

- Pick up the handset and continue talking.

To change from handset to speakerphone:

1. Press  **SPEAKER**.
2. Hang up the handset.



To end a speakerphone call:

- Press  **SPEAKER** again.

2.6 Mute

During an active call, the Mute feature prevents the party with whom you are speaking from hearing you. This feature is most commonly used in conjunction with the Speakerphone, but can be used to hold an off-line conversation at any time during a call.



To prevent the other person on the line from hearing you:

1. Press  **MUTE**. The other party cannot hear you. The indicator next to the MUTE button lights when MUTE is active.
2. To reinstate two-way conversation, press  **MUTE** again.

2.7 Hold

The HOLD feature puts a call on hold until you retrieve it.

To place a call on hold:

- Press  **HOLD**.
The line display area changes to white text with a dark gray background, and  is displayed.



To retrieve a held call:

- Press the corresponding  on which the call is being held. The call is now active.

2.8 Speed Dial

The [Speed Dial](#) ^[22] feature allows the phone to dial numbers stored in your personal directory (maximum of 104).

To make a call to a personal directory entry using the Speed Dial feature:

1. From the Home screen, press  **SpDial**. The **Speed Dial** screen is displayed.
2. Press the button next to the entry you want to call.
If the entry you want does not display, press  and  to search through the entries or key the first letter of the required name to jump to the page with a matching entry.

The phone dials the number for you.





2.9 Redial

The Redial feature automatically redials a previously dialed extension or outside number (up to 24 digits). The phone can store up to six of the last numbers dialed.

To redial a previously dialed number:





- Press  **REDIAL**. To search through the entries, press  and . When you have located the required number, press the associated key.

To change the REDIAL number selection:

1. Press  **OPTIONS** and press  **Application Options**.
2. Press  **REDIAL** to toggle between **Last 6 Numbers** and **Last Number**.
3. Press  **Save**. To restore the previous setting without changing it, press  **Cancel**.

2.10 Transfer

This feature allows you to transfer a call from your phone to another extension or outside number.

1. With a call in progress, press  **TRANSFER**.
2. When you hear dial tone, dial the number to which the call is to be transferred. Then do one of the following:
 - To transfer the call without announcing it (an unsupervised transfer), press  **TRANSFER** again. The transfer is complete.
 - To announce the call before transferring it (a supervised transfer), wait for the called party to answer:
 - If the called party is willing to accept the call, press  **TRANSFER** again to complete the transfer.
 - If the called party does not wish to accept the call or there is no answer, press  **DROP**. To return to the held call, press  adjacent to it.

2.11 Conference

The Conference feature allows you to conference other parties (including yourself) into a call.

Notes

- The number of parties allowed in a conference is controlled by your phone system.
- Two Call Appearance keys are required for the conference feature.

To add another party to a call:

1. Press **CONFERENCE**.
2. Dial the number of the person you want to add to the call.
3. To add the person to the call, press **CONFERENCE** again.
If the called party does not answer or does not want to join the conference, press **DROP**. To return to the held call, press **hold** adjacent to the held call.
4. Repeat steps 1 through 5 for additional conference connections.

To see the details of the different participants in the conference, press **Prev/Next**.

Notes

- To leave a conference call, hang up.
- To display which conference participants to drop from the conference, press **DROP**. You can then select the participant to drop by pressing the **Prev/Next** buttons to display the participant, then press **DROP** again.

2.12 Parking Calls

You can park one or more calls; allowing you to make and receive other calls. You can also arrange for the parked call to be retrieved by another extension.

The system only allows calls to be parked for a short while before reconnecting them to the user who parked the call; the default setting is 5 minutes. Once the set time is reached, the parked call will ring back if your extension is idle.

Note

- To park a call using the short codes, the call must first be put on [Hold](#) ⁽¹⁷⁾.

To park a call to be picked up by any extension:

- Dial ***37*N#** - Where **N** is the slot id you have assigned.
Inform your colleagues of the parked call and the slot id you have assigned.

To Un-park a call from another extension:

- Dial ***38*N#** - Where **N** is the assigned slot id.

To Park a call to your local extension:

- Dial ***37#**
When you park a call to your local extension, it is automatically given a slot id number based on your extension number followed by 0. If you park another call, it is given your extension number followed by 1 and so on up to 9. For example: if your extension is 201, the first parked call will be given the slot id **2010**.

To Un-park a call on your local extension:

- Dial ***38*#** - If you have more than one call parked, the call parked first will be the first call to be unparked

Note

- Feature keys can be setup to park and un-park calls. If required, contact your administrator.

2.13 Private Call

The Private Call feature is used to prevent any intrusions during the call. Private call can be activated either before or during a call and will set the phone status to 'cannot be intruded' until you switch the Private Call feature off.

If you place a call to an extension with Private Call on, you will hear the Number Unobtainable tone.

Note

- Private call is not a default feature. If you require this option, contact your administrator.

Chapter 3.





Speed Dials

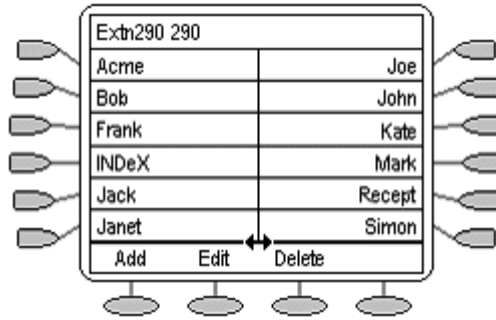

3. Speed Dials

The phone can store up to 108 personal speed dials. To access the speed dial directory, press  **SpDial**.

A screen similar to the following is displayed:



- The speed dials are sorted alphabetically.
- Press  or  adjacent to a name to dial the speed dial number stored with that name.
- The  symbol indicates that there are more pages. To move between pages, press  and .

To add a new speed dial, press  **Add**. To edit an existing speed dial's current settings, press  **Edit**.

A screen similar to the following is displayed:

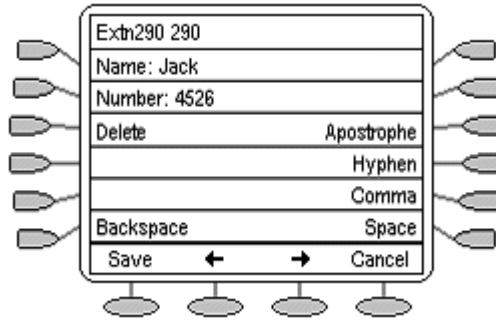







Note

- Speed dials can be used for any numbers that can be manually dialed from the extension. If, for external calls, a dialling prefix is required; that prefix must be part of the speed dial number.

3.1 Dialling a Speed Dial Number

To use the speed dial directory:











1. To display the speed dial directory, press  **SpDial**.
If **SpDial** is not shown, you may have to press  **PHONE/EXIT** to exit the current screen function.
2. The  symbol is shown if there is more than one page of speed dials. To move between pages, press  and .
3. When the speed dial required is shown on the screen, press  or  adjacent to the speed dial name. Continue as per a normal call.

3.2 Adding a Speed Dial from the Call Log

You can create a new speed dial from a call log entry. See [Turning a Log Entry into a Speed Dial](#)^[28]. This process will start the normal speed entry screen, pre-filled with the name and number from the call log entry.











3.3 Editing a Speed Dial

To edit a speed dial:

1. To display the speed dial directory, press  **SpDial**.
If **SpDial** is not shown, you may have to press  **PHONE/EXIT** to exit the current screen function.
2. The  symbol is shown if there is more than one page of speed dials. To move between pages, press  and .
3. Go to the page containing the speed dial to edit.
4. Press  **Edit**.
5. Press  or  next to the speed dial to edit. The editing process is similar to adding a new speed dial, see [Adding a New Speed Dial](#)^[24].
To remove the speed dial from the speed dial directory, press  **Delete** to confirm or to exit without deleting, press  **Cancel**.

3.4 Deleting a Speed Dial

To delete a speed dial:

1. To display the speed dial directory, press  **SpDial**.
If **SpDial** is not shown, you may have to press  **PHONE/EXIT** to exit the current screen function.
2. The  symbol is shown if there is more than one page of speed dials. To move between pages, press  and .
3. Press  **Delete**.
4. Press  or  next to the speed dial to delete.
5. To confirm, press  **Delete**. To exit without deleting, press  **Cancel**.

3.5 Adding a New Speed Dial

You can add a new speed dial to your directory.

To add a new speed dial:

1. To display the speed dial directory, press **SpDial**.
Note - If **SpDial** is not shown, you may have to press **PHONE/EXIT** to exit the current screen function.
2. Press **Add**.
A screen similar to the following is displayed:

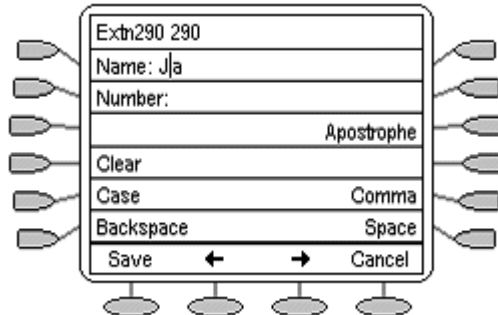

3. The cursor, a | symbol, displays in the empty name field. To move between Name and Number entry, press the adjacent **←**.
4. Begin entering text using the phone keypad. Each key is marked with the letters it provides. You may have to press the key more than once depending on the character you require.
 - For example, the **2** key is also marked as **A**, **B** and **C**. To enter a **C**, press the key until **C** is displayed.
 - If the next character you want to enter is on the same key, press **→** and then enter the next character.
5. As you enter characters you can use a number of other controls:
 - **Save** - Save the speed dial changes.
 - **←** - Moves the cursor left one character.
 - **→** - Moves the cursor right one character.
 - **Cancel** - Return back to the speed dial directory without making any changes.
 - **Clear** - Delete the whole name or number entry.
 - **Case** - Change the case of the current character between upper and lower case.
 - **Backspace** - Delete the character before the cursor.
 - **Apostrophe** - Insert an apostrophe (') symbol.
 - **Comma** - Insert a comma (,) symbol.
 - **Space** - Insert a space.

Note:

- The controls on this screen are context sensitive and only appear when applicable. For example, **Save** only appears when a name and number have been entered.

Chapter 4.

Using the Call Log

4. Using the Call Log



The phone maintains a call log. To access the call log, press  **Log**.

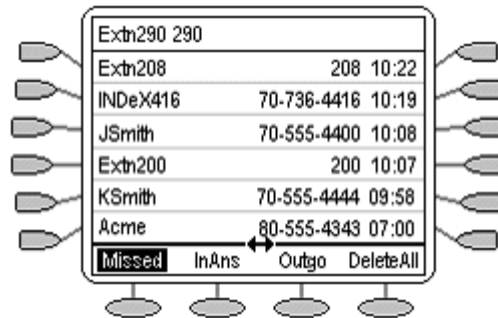

The call log keeps a log of missed calls, outgoing calls made and incoming calls answered. Each of these logs includes the 30 most recent calls in each category.

A log entry similar to the following is displayed:



Extn290	290	
Extn208	208	10:22
INDeX416	70-736-4416	10:19
JSmith	70-555-4400	10:08
Extn200	200	10:07
KSmith	70-555-4444	09:58
Acme	80-555-4343	07:00
Missed	InAns	Outgo
DeleteAll		

- The name of the called or calling party (if available).
- The number of the called or calling party.
- The time of the call.
- The date of the call (if prior to the current day).
- The  symbol indicates that the log contains more pages of entries. To move between pages, press  and .

Press  or  adjacent to a log entry to display full details of that log entry, similar to the following:

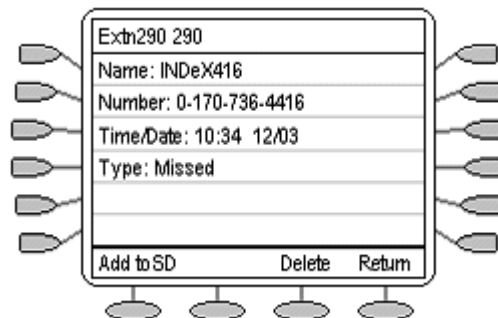

Extn290	290
Name:	INDeX416
Number:	0-170-736-4416
Time/Date:	10:34 12/03
Type:	Missed
Add to SD	Delete
Return	

Each individual log entry includes:

- The name of the called or calling party if available.
- The number of the called or calling party.
- The time of the call.
- The date of the call.
- The duration of the call for outgoing and answered calls.

Apart from using the call logs for information, you can turn a call log entry into a speed dial for future calls. You can also delete individual log entries or all entries in a particular log.

Note

- Call log entries are lost whenever the phone system or the individual phone are reset.

4.1 Accessing Call Logs

You can access the call log to view incoming, outgoing and missed calls.

To access call logs:

1. Press **Log**.
A screen similar to the following is displayed:

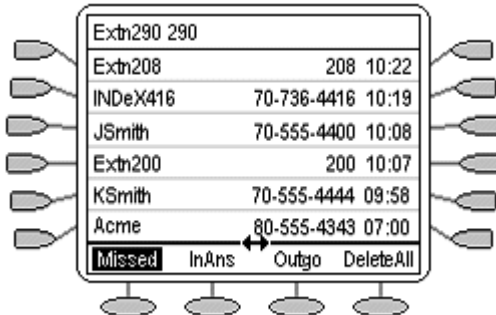

The call log always opens in the **Missed** calls log.

Note- If Log is not shown, you may have to press **PHONE/EXIT** to exit the current screen function.

2. To select the log required, press:
 - **Missed**: The log of missed calls, i.e. those that rang your extension but were not answered. This includes calls that were diverted to voicemail or another number after ringing your extension.
 - **InAns**: The log of incoming calls that were answered. This includes both internal and external calls.
 - **Outgo**: The log of calls made. This includes both internal and external calls.
3. If the selected log contains more than one page of entries, the **↔** is shown. To move between pages, press **◀** and **▶**.

4.2 Displaying an Individual Log Entry

You can display an individual log entry to view the name, number, date and time of incoming, outgoing and missed calls.

To display an individual log entry:

1. Locate the log entry in which you are interested.
2. Press **☎** or **☎** adjacent to the entry. The log entry details, similar to the following, is displayed:

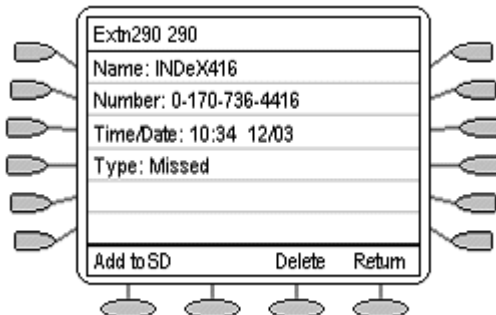





3. To return to the call log, press **Return**.

4.3 Making Calls from the Call Log

You can make internal and external calls from the call log.

To make calls from the call log:





1. Locate the log entry in which you are interested.
2. To display the log entry details, press  or  adjacent to the entry.
3. To make the call, press  **Call**.

If the number shown is external but does not include the external dialling prefix used by your phone system, go off-hook, dial the prefix and then press  **Call**.

4.4 Turning a Log Entry into a Speed Dial

You can add a log entry to your speed dial directory.





To turn a log entry into a speed dial:

1. Locate the log entry and press  or  adjacent to it.
2. Press  **Add to SD**.
3. The screen for editing and adding speed dials appears, prefilled with the information from the log entry. Edit the details if required and then press  **Save** or to return to the speed dials selection menu, press  **Cancel**.

4.5 Deleting an Individual Log Entry

You can delete an individual log entry from your call log.







To delete an individual log entry:

1. Locate the log entry and press  or  adjacent to it.
2. To delete the log entry and return to the call log, press  **Delete**.
To return to the call log without deleting the log entry, press  **Cancel**.

4.6 Deleting all Entries from a Log

You can delete all log entries from your call log.

To delete all entries from a log:

1. Press  **Missed**,  **InAns** or  **Outgo** to select the log.
2. Press  **DeleteAll**.
3. To delete the log entries, press  **Delete**.
To return to the call log without deleting the log entries, press  **Cancel**.







4.7 Exiting the Call Log

- Press  **PHONE/EXIT**.

4.8 Disabling the Call Log

The phone's call logging can be switched off if required.

To disable call logging:

1. Press  **OPTIONS** and then press  **Application Options**.
2. Press .
3. Press  **Call Log** to toggle between **Enabled** and **Disabled**.
4. Press  **Save**.
To abandon the changes, press  **Cancel**.

Chapter 5.

Visual Voice

5. Visual Voice

Visual Voice gives you access to your mailbox using softkeys and, by using the associated feature keys, a more user-friendly option control.

Visual Voice is accessed by pressing  **Voice** and then selecting from the displayed options:



- **Listen** - You can have direct access to your voicemail.
- **Message** - You can leave a message directly in a mailbox you specify.
- **Greeting** - You can listen to, change or delete your greeting message.
- **Password** - You can change your voicemail password
- **Email** - You can view or change your email alert status;
- **<Group>** - You can have direct access to voicemails for any group you are a member of; if you are the Group Mailbox Administrator.

Note

- The email option is only available if VoiceMail Pro is installed, and Voicemail Email has been configured for you.

5.1 Listen to Voicemails

To listen to your Voicemails or your Group Voicemails:

1. Press  **Voice**.
2. Press  **Listen** (for your messages) or  **<group name>** (for your hunt group messages), for example, Sales (25).
3. When prompted, key in the password. If your extension has been configured as a trusted source, the password will not be required.
Note - If you do not have the required password, contact your administrator.

You will be presented with the following message categories for your messages:

- New (5)
- Old (7)
- Saved (13)





Note - The total number of messages in each category is displayed in brackets.

4. Use the feature key to select the category, for example  **New**.

The first message in the selected category will play; and the following message handling feature key options are displayed:

- **Next** - Plays next message.
- **<<** - rewinds current message by 5 sec
- **>>** - fast forwards current message by 5 sec
- **Pause**- pauses the current message/resumes playing
- **Delete** - Delete the current message.
- **Save** - Change the current message's category to 'saved'
- **Previous** - Plays previous message
- **Copy**- Copy the message to another mailbox or mailboxes. If selecting more than one mailbox, the entries must be separated with a #.

To add a covering message to the copied voicemail.

1. Press  **Copy**, and add the recipients. The feature keys change to the copy options.
2. Press  **Pre-Rec**
3. Record your message
4. Press  **Stop**
5. Press  **Listen** to check your message. You can change the message by selecting Pre-Rec again.
6. Press  **Send**.

Note

- Depending on the number of feature keys available, you may need to use the scrolling facility to see all of the options.



5.2 Changing Your Greeting

You can listen to, change and save your current greeting.

Note

- Visual Voice only modifies your Personal Greeting for All Calls.





To change your mailbox greeting:

1. Press  **Voice**.
2. Press  **Greeting**. The following options are then displayed on the soft-keys.
 - Record - starts recording.
 - Listen - to hear your current greeting.
 - Submit - saves the new greeting.
 - Delete - deletes your current greeting.

To listen to your current Greeting:





1. Press  **Listen**.

To Record a new Greeting:

1. Press  **Record**. The **Stop** soft-key is then displayed.
2. Record your Greeting and then press  **Stop**.
3. Press  **Listen** to hear the message you have just recorded; re-record if you are not satisfied with the Greeting.
4. Press  **Submit** to save the new Greeting.
5. Press  **PHONE/EXIT** to return to the main display.

5.3 Send a Voicemail

To send a message to another person or Group:

1. Press  **Voice**.
2. Press  **Message** and dial the extension of the person or Group.
3. Press  **Message** again. The soft-key **Record** is displayed.
4. Press  **Record**. The **Stop** soft-key is displayed.
5. Record your message and when finished, press  **Stop**.

After recording your message, the following soft-key options are displayed:

- **Record** - Re-record your message.
- **Listen** - Listen to the message you just recorded.
- **Submit** - Submit (send) the message.
- **Others** - Add other recipients; each entry separated by a #. Then press  **Done**.





When you have submitted your message, press  **PHONE/EXIT** to return to the main display.







5.4 Email Alerts

The Email option is displayed if:

- You have Voicemail pro installed
- and
- Voicemail Email has been configured for you.

To view or change the current email alert status:

1. Press  **Voice**.
2. Press  **Email**. You will be prompted for your current voicemail password. The current voicemail email alert status is shown along with Change and Done soft-keys.
3. Select either:
 -  **Done** - To exit leaving the current alert status active
 -  **Change** - To change the status.



Note - The  Change soft-key will toggle through the alert status, beginning with the current status.
4. Chose one of the following status:
 -  **OFF** - No email alerts are sent.
 -  **COPY** - An email alert is sent with a copy of the voicemail attached.
 -  **FWD** - An email alert is sent with a copy of the voicemail attached. The original voicemail is deleted from your voicemail mailbox.
 -  **ALERT** - An email alert is sent when there is a new voicemail.
5. When you have made you selection, press  Done

5.5 Changing Your Mailbox Password

Note

- When changing your mailbox password it is advisable not to use sequential numbers (1234, 6789, 8765, etc.) or existing extension numbers.

To change your Mailbox password:



1. Press  **Voice**.
2. Press  **Password**.
3. When prompted, key in your new password (minimum of 4 digits) and press  **Done**.

The display will exit to the main display if the change was accepted. Otherwise you will be prompted to try again.

5.6 Voicemail Transfer

Unlike the standard transfer, Voicemail Transfer allows you to transfer a call to another user's **mailbox**.

To transfer the call to another mailbox:

1. Press  **Voice**
2. Key in the user's extension number.
3. Press  **Vmail Transfer**.

The call will be transferred directly to the users mailbox; the extension is not alerted.

Chapter 6.





Changing Options

6. Changing Options

6.1 Personal Ringing Options

The IP Office uses 'distinctive ringing' for different types of calls - a repeated single ring for internal calls, a repeated double ring for external calls and a single ring followed by two short rings for ringback calls. These options are fixed by the IP Office. The phone's own menus allow its ringer sound to be personalized so you can recognize it from other ringing phones.

To hear a ring pattern and change the Personal Ringing options:





1. Press  **OPTIONS** and then press  **Personal Ringing**. This alters the tone and style of ringing used by the phone, the ring pattern is still controlled by the IP Office according to the call type.
2. Press the corresponding  to the left or right of any numbered pattern. The **Current Pattern** number changes to the selected pattern, which rings once as a sample.
3. Repeat Step 1 until the preferred pattern appears as the **Current Pattern**.
4. To save the setting, press  **Save**.
Upon saving or canceling, the first Options main screen is displayed.

6.2 Viewing IP Settings

Views of phone and system information are available from this screen. You do not normally need to view this information, however your system administrator may ask you to report certain values from any of the status screens in the event of problems.

The status screen data can be viewed, but cannot be changed.

To view IP settings:

1. Press  **OPTIONS** and then press  **View IP Settings**.
2. There are two pages of display. Press  and  and select from:
 - **IP Address Settings**
IP (Internet Protocol) address information identifies certain components and connections. The IP Address information includes the location (address) of your phone on the IP Office unit, the location and port (connection) of the IP Office itself, the call routing and mask addresses, and the identification of the File Server with which your phone interacts. Although technical in nature, having this information available and knowing how to get to it can assist your system administrator in tracking questions about or problems with phone functions or connections.
 - **Quality of Service (QoS) Information**
QoS refers to a number of mechanisms used to improve audio quality over the network.
 - **Phone Interface**
Your phone interfaces with several system hardware devices and software. This screen provides information about three of the main interfaces.
 - **Miscellaneous Information**
The miscellaneous status screens provide additional information about your phone and its connections.
3. To return to the first **View IP Settings** screen, press  **Return**.







6.3 Contrast Control

On first-time startup, the phone's display area contrast is set to mid-level. Should you need to adjust it, to better suit your work environment and lighting, fifteen contrast levels are available.

Note

- You may not be able to distinguish between all 15 contrast level settings. Some of the upper and/or some of the lower contrast level settings may appear identical to adjacent settings. This is normal.

To adjust the contrast level:

- Press  **OPTIONS** and then press  **Contrast Control**.
- To adjust the contrast, press  or  until you reach the desired contrast level. ( symbols provide visual confirmation of the current level).
- To save the contrast level you set, press  **Save**.
To restore the previous setting without changing the contrast, press  **Cancel**.

6.4 Reinstating the Phone

If your phone is not registered on the phone system, the top line displays "Extension=*."

To reinstate your phone following a log off:

The phone screen displays your extension number.















- Press the Hash (#) key. If the screen does not display your extension number, use the dialpad to enter the number, then press the Hash (#) key.
- The display prompts for entry of your password. Using the dialpad, enter your PBX/switch Password then press the Hash (#) key. If a password was set by the system administrator, enter any number and press Hash (#).

The phone is now ready for use.

6.5 Changing Key Labels

This feature can be used to edit and change the text label shown next to buttons.

To change the feature key labels:

1. Press  **OPTIONS** and then press .
2. Press  **Feature Button Labeling**.
3. Select from:
 - **Relabel feature buttons:** proceed from next step:
 - **View Default labels**
 - **Restore default labels:** restores any previously renamed feature labels to their default state.
4. Select the function key whose label you wish to change. The display will change to show the editing menu with **New:** highlighted.
5. Enter the new text using the phone keypad. Each key is marked with the letters and number it provides. You may have to press the key more than once depending on the character you require.
 - For example, the key 3 is also marked as **D**, **E** and **F**. To enter **D**, press **3**.
 - If the next character you want to enter is on the same key, press  to move the cursor right and then enter the character. Alternatively, key the next character.
 - By default the first letter is entered in upper-case and the phone then switches to lower-case entry mode. To change the case of the current character, press  **Case**.
 - To enter a space, press  **Space**.
 - If you make a mistake, press  **Backspace** to delete the character to the left of the cursor.
 - If you have make a mistake in the middle of the text, use the  key to backspace and then  **Backspace** to delete the character to the left of the cursor.
 - To delete the complete entry, press  **Clear**.
 - You can also enter an **Apostrophe**, **Hyphen** or **Comma** as required.
6. When the new name is set as required, press  **Save**.
7. To return to the Label screen without saving the changes, press  **Cancel**.
8. To return to the main Options menu, press  **Return**.
9. To return to the call handling screen without saving the changes, press  **PHONE/EXIT**.







6.6 Displaying Language Selection

Non-English speaking users can change the user interface language displayed on their phone. Language options are: English, Français, Italiano, Japanese (Katakana characters), Español, Deutsche, Nederlands, Português.

Note

- This does not alter your language setting on the phone system.

To change the language:

1. Press  **OPTIONS**.
2. Press  and then press  **Language**. A menu listing the available languages is displayed.
3. To search for the language required, press  or . You are asked in the original language **Are you sure?** with the same message in the new language below.
4. Do one of the following:
 - To return to the options menu without saving any changes, press  **Return**.
 - To save the settings and return to the options menu, press  **Yes** (which is displayed in both the original and the selected language).





6.7 Phone Screen on Answer

This action controls the phone screen display when the phone is answered.

When the **Phone Screen on Answer?** option is set to **Yes**, the phone screen displays when you answer a call, regardless of the screen you were working with at that time. You will lose any unsaved work in progress on that screen (for example, labeling a Speed Dial button), except for the Web Access application (which "remembers" the current web screen).

When the **Phone Screen on Answer?** option is set to **No** (the default setting), when you answer a call it has no impact on the application screen displayed, although the top display line provides an appropriate message.

To change Phone Screen on Answer:

1. Press  **OPTIONS** and then press  **Application Options**.
2. Press  **Phone Screen on Answer** to toggle between **Yes** and **No**.
3. Press  **Save**. To abandon the changes, press  **Cancel**.





6.8 Phone Screen on Calling

This action controls the phone screen display when you make a call.

When the **Phone Screen on Calling?** option is set to **Yes** (the default setting), the phone screen displays when you make a call, regardless of the screen you were working with at that time. You will lose any unsaved work in progress on that screen (for example, labeling a Speed Dial button).

When the **Phone Screen on Calling?** option is set to **No** when you answer a call it has no impact on the application screen displayed, although the top display line provides an appropriate message.

To change Phone Screen on Calling:

1. Press  **OPTIONS** and then press  **Application Options**.
2. Press  **Phone Screen on Calling** to toggle between **Yes** and **No**.
3. Press  **Save**. To abandon the changes, press  **Cancel**.

6.9 Displaying Call Timers

This action controls whether the duration of the current call is displayed or not. If set to **Yes**, the duration of the current call is displayed on the call appearance key. If set to **No**, the call duration will not be displayed.

To change the Display Call Timers status:

1. Press **OPTIONS** and then press **Application Options**.
2. Press **Display Call Timers?** to toggle between **Yes** and **No**.
3. Press **Save**.
To abandon the changes, press **Cancel**.

6.10 Message Display Rate

When the IP Office sends messages to your phone that are longer than the display area, the first part of the message is presented for a specific time interval. The second part of the message is then displayed for a specific time interval. The Message Display Rate can be either **Fast** (display interval is 2 seconds) or **Slow** - default (display interval is 3 seconds).

To change Message Display Rate:

1. Press **OPTIONS** and then press **Application Options**.
2. Press **Display Call Timers?** to toggle between **Fast** and **Slow**.
3. Press **Save**. To abandon the changes, press **Cancel**.

6.11 Call Appearance Width

When the Call Appearance Width is set to **Full** (the default), each line on which a call appears extends the full width of the display, and accommodates messages in the call appearance display area. When this option is set to **Half**, the call appearance area is limited to half of the display area and call-related messages appear on the top display line.

To change call appearance width:

1. Press **OPTIONS** and then press **Application Options**.
2. Press **Call Appearance Width** to toggle between **Full** and **Half**.
3. Press **Save**. To restore the previous setting without changing it, press **Cancel**.

6.12 Visual Alerting

When this option is set to **No** (the default), ringing is the only notification of an incoming call. When set to **Yes**, your phone rings and your voice message indicator light flashes to alert you to an incoming call.

To change Visual Alerting:

1. Press **OPTIONS** and then press **Application Options**.
2. Press and then press **Visual Alerting** to toggle between **Yes** and **No**.
3. Press **Save**. To restore the previous setting without changing it, press **Cancel**.

Chapter 7.



Function Keys



7. Function Keys

Both the Function Keys and the Soft Keys can be used to access a range of system features. The display adjacent to the key shows the feature name.





Some of these features are default features, for example **SpDial**, **Log** and **Option** which are always available. Others are system features that **can only be programmed by the system administrator**. See [Function Key Programming](#)^[45].

In addition, there are a number of System Features that you **can always access yourself** by the use of short codes. Refer to the [System Features Introduction](#)^[50] for details of System Features that you can always access yourself by dialling short codes. For example, to listen to your voicemail messages, dial ***17**.

The main screen has 2 pages. This means that the 12  and  Function Keys on each page could be used for up to 24 features. However, it is **strongly recommended** that all three Call Appearance keys **remain at their default settings**. Hence, there are 21 soft Function Keys that can be allocated to system features.

To move between pages, press  and .

In the following example:

- The first three keys have been set as call appearance lines.
- Keys 4 and 5 have been set to access the **Admin** and **Admin1** programmable functions.
- Key 6 has been set to monitor system park slot 1. The  indicates a call is currently parked in slot 1.
- Key 7 has been set to the SAC (Send All Calls) function.
- Key 8 has been set to VMOn, a function which toggles use of the voicemail mailbox to on/off. The  indicates that this function is currently on.
- Press  or  to display the other two pages of programmed functions set for this phone.

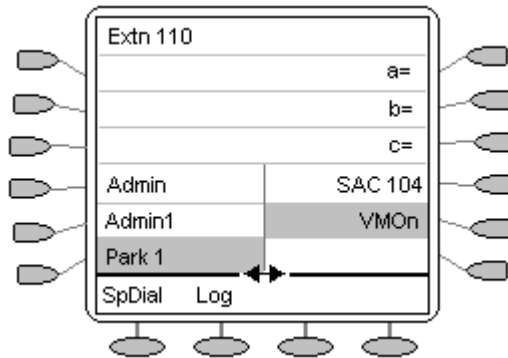

Programming your own features:

If the phone has been setup with either or both the Admin and Admin1 features assigned to display keys, you can select and program your own feature choices against other keys. See [Function Key Programming](#)^[45].

7.1 Function Key Programming

If any one of the keys on the phone is programmed with an **Admin** or **Admin 1** feature key, it allows you to program further features against other function keys. Both **Admin** and **Admin1** are allocated to your function keys by your system administrator and displays on a menu screen similar to the following:

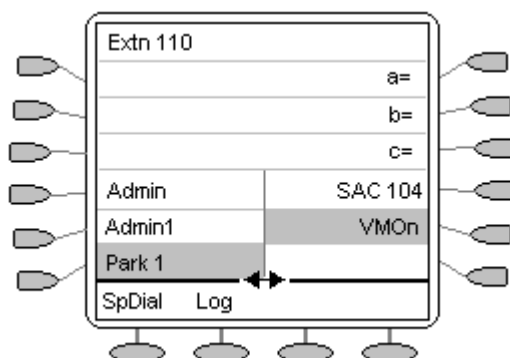

The two tables below list the user programmable features available from **Admin** and **Admin1**. For full details of how each function works see [System Features](#) ⁽⁵⁰⁾.

Admin: The programmable functions available via an **Admin** key are:



Name	Description	Toggles	Data
Acct	Account Code Entry	No	Optional
AD	Abbreviated Dial	No	Yes
Admin	Self-Administer	No	No
AutCB	Automatic Callback	Yes	No
CFrwd	Call Forwarding All	Yes	Optional
CPark	Call Park	Yes	Optional
CPkUp	Call Pickup	No	No
Dir	Directory	No	No
DPkUp	Directed Call Pickup	No	Yes
DROP	DROP	No	No
GrpPg	Group Paging	No	Yes
HdSet	HEADSET Toggle	Yes	No
HfAns	Internal Auto-Answer	Yes	No
HGNS+	Set Hunt Group Night Service	Yes	Yes
Park	Call Park to Other Extension	No	Yes
Prog	Abbreviate Dial Program	No	Yes
RngOf	Ringer Off	Yes	No
SAC	Send All Calls	Yes	No
Spres	AD Suppress	Yes	No
Timer	Timer	Yes	No
TmDay	Time of Day	Yes	No

In addition to the above, there is a key labeled **Exp?** This key enables you to change the display from the shorthand version displayed at default to a longhand version of your own. See [Shorthand Programming Mode](#)^[47] and [Longhand Programming Mode](#)^[48] respectively.

Admin1: The programmable functions available via an **Admin1** key.

Name	Description	Toggles	Data
Park	Park	No	Yes
User	User	No	Yes
Group	Group	No	Yes
Number	Dial	No	Yes
Flash	Hook Flash	No	No

7.2 Shorthand Programming Mode

1. Press  **Admin** or  **Admin 1**. See [Function Key Programming](#) ^[45].
2. The **Admin** or **Admin1** menu is displayed, similar to the following:



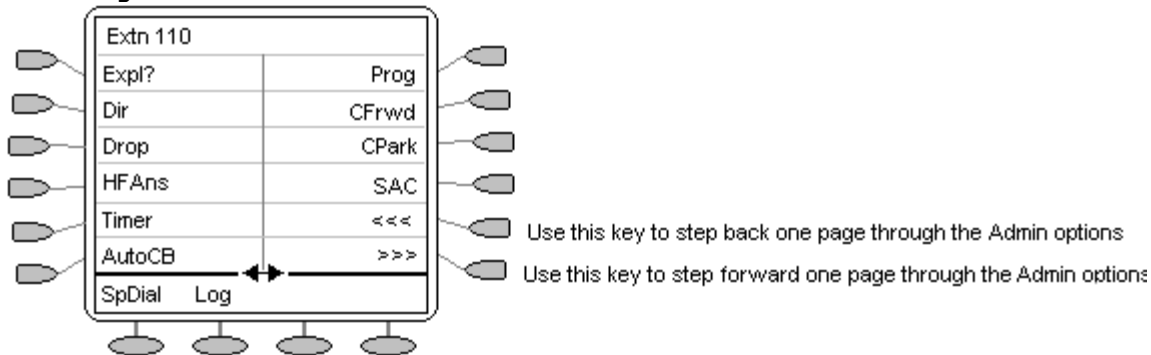



Admin Pages

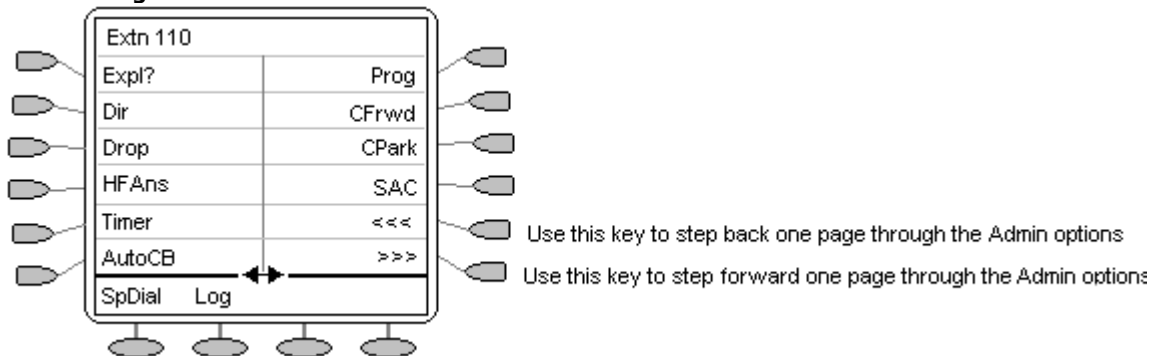







With the exception of **Expl?**, the names shown are the features that you can assign to soft keys. When **Admin** has been selected you can display the full name of the feature by pressing **Expl?**. See [Longhand Programming Mode](#) ^[48].

Admin1 Page



3. On the **Admin** pages, press  and  to move through the list of feature.
4. When the function required is displayed, press  adjacent to its name.
5. If the function requires some data to be entered, [] is shown at the bottom of the display. Enter the data using the normal phone keypad.
6. The upper part of the display shows the functions currently assigned to each  and .
7. To select the display key against which to program the new function, press  or .

Caution - Do not select the slot used for the **Admin** function.
Replacing this function will lock the phone for further programming until reset through the phone system.
8. If the display slot is not already used, the display shows **BUTTON PROGRAMMED!**.
 - To end programming, press  **PHONE/EXIT**.
 - To continue programming other functions, press  **Cont.**
9. If the display slot already has a programmed function, the display shows **FEATURE ON BUTTON**. Press  or  until **Repla**, **Keep** and **Delet** are shown along the right-hand edge of the display.
 - To replace that existing function with the one just programmed, press **Repla** . **BUTTON PROGRAMMED!** is displayed.
 - To keep the existing function and forget the function just programmed, press **Keep** .
 - To delete the existing function and forget the function just programmed, press **Delete** .

7.3 Longhand Programming Mode

1. Press **Admin** or **Admin 1**. See [Function Key Programming](#).
2. To switch to longhand programming mode, press **Expl?**.
3. Press **Next** until the required function required is shown, then press **Select**.
4. If the function requires some data to be entered, [] is shown at the bottom of the display. Enter the data using the normal phone keypad.
The upper part of the display reverts to showing the functions currently assigned to and .
5. To move between the pages of display keys, press ◀ and ▶.
6. To select the display key against which to program the new function, press or .
Caution - Do not select the slot used for the **Admin** function. Replacing this function will lock the phone for further programming until reset through the phone system.
7. If the display slot is not already used, the display shows **BUTTON PROGRAMMED!**.
 - To end programming, press **Phone EXIT**.
 - To continue programming other functions, press **Cont.**
8. If the display slot already has a programmed function, the display shows **FEATURE ON BUTTON**. Press ◀ and ▶ until **Repla**, **Keep** and **Delet** are shown along the right-hand edge of the display.
 - To replace that existing function with the one just programmed, press **Repla**. The display then shows **BUTTON PROGRAMMED!** as above.
 - To keep the existing function and forget the function just programmed, press **Keep**.
 - To delete the existing function and forget the function just programmed, press **Delete**.

Chapter 8.

System Features

8. System Features

As well as your phones specific features, you can access a number of system features by dialling short codes.

These instructions are for the system's default configuration. They assume that you are using the default feature codes. It also assumes that you have full access to all features and the public phone network.

8.1 Ring Back

If your system administrator has allocated you the *Ring Back When Free* feature , you can perform the following:

1. When you call an extension that does not answer or is busy, press  **RBak** to set a callback on that extension. When the extension you called becomes free, your phone rings (a burst of three rings).
2. Lift the handset and the extension is called automatically. When the extension you called is free, your phone rings (a burst of three rings).

8.2 Call Waiting

Call Waiting tells you if another call arrives while you are already making a call by providing call waiting tone. If you hear the call waiting tone, either end your current call or put the caller on hold. The waiting call should then ring.

To turn call waiting on, dial ***15**. To turn it off, dial ***16**.

Note

- Call Waiting is only used for a single line phone with no call appearance buttons programmed.

8.3 Call Forwarding

Your calls can be forwarded to another extension or an external number when:

- You are away from your desk (on no answer).
- Your extension is busy (on all Call Appearance keys).
- You are away from the office (e.g. when you are on holiday).

The following options are available for call forwarding:

- To set the number to which your calls are forwarded, dial ***07*201#** (forwarding to 201 in this example).
- To switch Forward Unconditional On (i.e. not Hunt Group), dial ***01**. A **D** is displayed. To switch it off, dial ***02**.
- To switch Forward On Busy On, dial ***03**. To switch it off, dial ***04**.
- To switch Forward On No Answer On, dial ***05**. To switch it off, dial ***06**.
- To switch Forward Hunt Group Calls On, dial ***50**. To switch it off, dial ***51**. This setting is for Forward Unconditional On only.
- To Cancel All Forwarding, dial ***00**.

Note

- Cancelling all forwarding will also cancel any [Follow Me](#)  you have set.

8.4 Diverting Calls

You can divert your calls to another extension using **Follow Me**. Unlike **Forward**, **Follow me** can only be used to divert calls to another internal extension on the same IP Office.

Note

- If you do not answer calls at the temporary extension, they are forwarded to your own voicemail or call forwarding number.

To use Follow-Me-Here from another extension:

In this case, **N** is your home extension

- Dial ***12*N#** from the extension you are temporarily using.
- Dial ***13*N#** to re-direct the calls back to your own extension, before you return to it.

To use Follow-Me-To from your home extension:

In this case, **N** is the extension to which you want your calls diverted.

- Dial ***14*N#** from your own extension.
- Dial ***14*#** to cancel either feature from your own extension.

Notes

- If you use the option **Cancel All Forwarding** (see [Call Forwarding](#)^[50]), your **Follow Me** will also be cancelled.
- **Follow Me** does not apply to the following call types:
 - Voicemail Callback
 - Automatic Call Back
 - HOLD or Park return.

8.5 Do Not Disturb

You may choose to receive no calls at all or only those from particular callers on your exceptions list:

- To switch Do Not Disturb on/off (with or without exceptions), dial ***08**. An **N** is displayed. To switch it off, dial ***09**.
- To add a number to the exception list, dial ***10*N#**
- To delete a number from the exception list, dial ***11*N#**

Note

- Your callers, other than your exceptions, either hear a busy tone or are re-directed to your voicemail.
- The only call that will ignore the Do Not Disturb rule will be one where you were the original caller, then performed an unsupervised transfer to another extension. If that extension does not answer, the call will be re-directed to you as the originator.

8.6 Voicemail

You can enable voicemail to allow callers to leave messages when you are out of the office, away from your desk or engaged on another phone call. Voicemail messages can be retrieved internally or externally via any phone. Your voicemail may be set up to deliver your messages by calling you whenever you hang up: this feature is known as *Voicemail Ringback*.

Note

- Not all systems support voicemail or have voicemail installed.

The following options are available for voicemail:

- To switch voicemail on, dial ***18**. To switch it off, dial ***19**.
- To retrieve your voicemail, dial ***17**.
- To turn Voicemail Ringback on, dial ***48**. To turn it off, dial ***49**.

Dialling a number while listening to your messages invokes more facilities; for further details on these facilities refer to the Voicemail User Guide.

Notes

- Once messages have been delivered, they are held on the system for 24 hours (this is fixed for Voicemail Lite, but can be varied by your system administrator if your IP Office is equipped with VoicemailPro).
- You can collect your voicemail from another extension by using the PIN your system administrator has set up for you. You can collect your messages if you are out of the office, by either dialling from a number that has been registered for the purpose or by dialling your extension number and PIN when prompted. If validation is successful, then dial **2** to retrieve your mail.
- The system administrator also specifies the reception number, to which the call is diverted if the caller dials **0**, and your email address if your voicemail and email are integrated.

8.7 Default Short Codes

The following are the normal default short codes available to you. Your system administrator may add additional codes for other features and for speed dials.

The **N** where shown, should be replaced by the appropriate number. For example, with ***07*N#**, replace **N** with the extension to which you want your calls forwarded when you have forwarding switched on.

*00	Cancel All Forwarding	*32*N#	Call Pick Up Extension
*01	Forward Unconditional On	*33*N#	Call Queue
*02	Forward Unconditional Off	*34	HOLD Music
*03	Forward On Busy On	*35*N#	Extn Login
*04	Forward On Busy Off	*36	Extn Logout
*05	Forward On No Answer On	*37*N#	Park Call
*06	Forward On No Answer Off	*38*N#	Ride Call
*07*N#	Forward to Number	*39	Relay On
*08	Do Not Disturb On	*40	Relay Off
*09	Do Not Disturb Off	*41	Relay Pulse
*10*N#	Do Not Disturb Exception Add	*42	Relay On
*11*N#	Do Not Disturb Exception Delete	*43	Relay Off
*12*N#	Follow Me Here	*44	Relay Pulse
*13*N#	Follow Me Here Cancel	*45*N#	Call Steal
*14*N#	Follow Me To	*46	Call Steal
*15	Call Waiting On	*47	CONFERENCE Add
*16	Call Waiting Off	*48	Voicemail Ringback On
*17	Voicemail Collect	*49	Voicemail Ringback Off
*18	Voicemail On	*50	Forward Hunt Group Calls On
*19	Voicemail Off	*51	Forward Hunt Group Calls Off
*20*N#	Set Hunt Group Night Service	*52	Clear Call
*21*N#	Clear Hunt Group Night Service	*53*N#	Call Pickup Members
*29	Toggle Calls	*57*N#	Forward On Busy Number
*30	Call Pick Up Any	*70*N#	Dial Physical Extn by Number
*31	Call Pick Up Group	*71*N#	Dial Physical Extn by ID

Chapter 9.

Web Browsing

9. Web Browsing

The phone can act as a web browser for WAP (Wireless Application Protocol) web sites. These web sites contain pages written in a language called WML (Wireless Markup Language). Your phone supports WML1.2.

If your phone system has been setup with a default WAP website, the phone displays  **Web**. Press this key to display your system's default WAP website. The links and services on this site will control the WAP website and services you can access.





While browsing, you can still make and receive calls. However, if you have **Phone Screen on Answer** option set to **Yes** and you answer an incoming call, the default phone screen will replace the existing web page in the display area.

To enter web browsing mode:

- Press  **Web**.

To exit web browsing mode:

1. Press  **PHONE/EXIT**.
2. If you press  **PHONE/EXIT** while browsing the web, the last web page viewed is displayed when you press  **Web** again before a system reboot.

9.1 Accessing External WAP Websites

Your default WAP web site may contain a page where you can select or enter the URL of external WAP websites. If this is the case, you should be aware that some website may contain information that the phone is not able to display.

If the WAP web page uses WML features that the phone does not support, those features will not be shown.

If the WAP web page uses features that the phone does not recognize as valid WML 1.2, the phone will display '**Not a valid WML page**'.

9.2 Web Navigation Controls

On your default WAP website (press **Web** to access), the phone display shows a number of navigation controls, similar to the following:



- Navigation Icon Buttons:** These appear on the right-hand side of the web display.

Note - Disabled navigation icon buttons may appear grayed out.

 - ▲ Up Page:** To move up the page by one screen (six lines).
 - ↑ Up Line:** To move up the page by one line, press the adjacent .
 - 🏠 Home:** To return to the default WAP website's home page, press the adjacent .
 - 🔄 Refresh:** To reload the current page, press the adjacent . If you had already selected another page to load this will cancel the loading of that page and reload the current page.
 - ↓ Down Line:** To move down the page by one line, press the adjacent .
 - ▼ Down Page:** To move down the page by one screen (six lines), press the adjacent .
- Link Buttons:**

The keys at the left hand edge of the screen are used to select links within the displayed web page. Links are indicated by underlined text. Only one link will appear on a line, press the adjacent to activate that link.
- Page Buttons:**

The keys across the base of the web display may be used to provide labeled links to other pages. If there are more than 3 such links, **More** is displayed. To display the additional options, press **More**.
- Phone Icon:**

If the icon appears next to a link in the web page, it indicates that the link is a phone number. Press the adjacent to select the link to dial the number.

9.3 Entering Data

Some web pages may require you to enter data into a text field and then submit that data. For example, if you browse to a search engine web site such as Google, you may be asked to enter a search field.

- : **Option (Radio Buttons)** - To select an option from a list, press the adjacent . The selected option appears as .
- : **Text Entry Fields** - These normally appear as **[Enter text here]** or pre-filled with some data.
- **Submit Buttons** - Text entry and option key selections are not completed until submitted. Normally this will be done by a link. Press or , labeled **Submit** or similar. The exact appearance will vary between different web pages.

To enter text into a text entry field:

1. Press adjacent to the text entry field.
2. The four keys at the bottom of the screen change to:
 - **DONE:** When your text entry is complete, press .
 - **BKSP:** To delete the previous character, press .
 - **SPACE:** To add a space, press .
 - **alpha:** This indicates the current text entry mode (in this example lower-case letters). To select a different text entry mode, press .
3. Begin entering text using the phone keypad. Each key is marked with the letters it provides. You may have to press the key more than once depending on the character you require.
 - For example, the **2** key is also marked as **A**, **B** and **C**. To enter **C**, press the key three times.
 - If the next character you want to enter is on the same key, press **1** and then enter the next character.
4. The right-most indicates the current text entry mode. To change the current mode, press the right-hand key. The available modes are shown along the bottom of the screen. They are:
 - **ALPHA:** Enter upper-case letters using the phone keypad.
 - **alpha:** Enter lower-case letters using the phone keypad.
 - **Num:** Enter numbers using the phone keypad.
 - **Symbol:** Enter a symbol from the displayed menu. Possible symbols are:
., # @ * ' " ; : \ / - | \$ % ! ? & + = > < () ~ _ ^ [] { }

These are arranged in pages and you may have to press **MORE** to select the required page. To enter a symbol, press next to it.
5. When you have completed your text entry, press **DONE**.
6. To return to the text entry, press adjacent to the text entry field again.

Chapter 10.

Management and Troubleshooting

10. Management and Troubleshooting

This chapter provides information for:

- Testing your phone to be sure it is operating correctly.
- Basic Troubleshooting; this chart provides the most common problems an end user might encounter and suggested resolutions.
- Application-specific troubleshooting; this chart describes problems and solutions specific to phone applications; Speed Dial, Call Log or Web Access.
- Resetting or power-cycling your phone, when Basic Troubleshooting does not resolve a problem.

10.1 Testing the Phone's Lights and Display

1. With the phone idle (on-hook), press and release  **MUTE**, then press the following numbers on the dialpad: **8 3 7 8 #** (which reads out 'TEST').

The display should indicate the self-test has started. If the test is successful, the message "Self test Passed #=end" displays; if the test is not successful, the message "Self test Failed #=end" displays instead.

2. To return to the phone screen, press #.
If nothing appears on the display and the phone is receiving power, your phone may need to be replaced. Contact your system administrator for assistance or additional troubleshooting information.

10.2 Troubleshooting Chart

This section details the most common problems an end user might encounter and suggested resolutions:

- **Phone does not activate when connected for the first time:**
Unless your system administrator has already initialized your phone, you may experience a delay of several minutes before it becomes operational. Upon plug-in, your phone immediately begins downloading its operational software, its IP address and any special features programmed by your system administrator from the server to which it is connected. Report any delay of more than 10 minutes to your system administrator.
- **Phone does not activate after a power interruption:**
Allow a few minutes for re-initialization after unplugging, powering down the phone, server problems, or other power interruption causes.
- **Display shows an error/informational message:**
Most messages involve server/phone interaction. If you cannot resolve the problem based on the message received, contact your system administrator for resolution.
- **SPEAKERphone does not operate:**
Ask your system administrator if your SPEAKERphone has been disabled.
- **Characters do not appear on the display screen:**
 - See "Phone does not activate when connected for the first time" above.
 - Check all lines into the phone to be sure it is properly connected.
 - Check the power source to be sure your phone is receiving power.
 - Perform the following test procedure: with the phone idle (on-hook), press and release **MUTE**, then press the following numbers on the dialpad: **8 3 7 8 #** (which stands for TEST). The display should indicate the self-test has started, then report if the test was successful or failed. If nothing appears on the display, and the phone is receiving power, your phone may need to be replaced.
 - If the above suggested solutions do not resolve the problem, reset or power cycle the phone with your system administrator's assistance.
- **No dial tone:**
Make sure both the handset and line cords into the phone are securely connected. Note that there may be a slight operational delay if you unplug and reconnect the phone. If the problem persists, contact your system administrator.
- **Phone does not ring:**
To set your ringer volume to a higher level, press **▲** and **▼**. From another phone, place a call to your extension to test the above suggested solution.
- **All other IP problems:**
Contact your system administrator.

SPEED DIAL APPLICATION:

- **You cannot dial out using any Speed Dial entries:**
Dial button. Check that all call appearances (incoming/outgoing lines) are not already in use. If all lines are in use, wait until a line is available to make your call.
- **You cannot add an entry to the Speed Dial list:**
You have 108 Speed Dial entries, the maximum allowed. You must delete at least one entry before adding a new entry.

CALL LOG APPLICATION:

- **You cannot dial out after selecting a call log entry:**
Check that all call appearances (incoming/outgoing lines) are not already in use. If all lines are in use, wait until a line is available to make your call.
- **You cannot add an entry to the Speed Dial list:**
You have 108 Speed Dial entries, the maximum allowed. You must delete at least one entry before adding a new entry.
- **Dialling from this application does not go through:**
Your system administrator must administer settings for the Enhanced dialling feature beyond the defaults.

WEB APPLICATION:

- **Pressing  Web does not display a website:**
Check with your LAN administrator to see if the web server is down, if there are network connectivity problems, or other network problems.
- **Dialling from this application does not go through:**
Your administrator must administer settings for the Enhanced dialling feature beyond the defaults.

OPTIONS:

- **No Options other than "View IP Settings" display:**
Your administrator has turned off all user-settable options.

Index

A

- Accessing
 - Call Logs 27
 - External WAP Websites 57
- Adding
 - New Speed Dial 24
 - Speed Dial 23
- All Entries
 - Deleting 28
- Answering
 - Calls 14

C

- Call Appearance Keys 9
- Call Appearance Keys Icons 10
- Call Appearance Width 41
- Call Forwarding 50
- Call Log 23, 28
 - Accessing 27
 - Disabling 28
 - EXITing 28
- Call Waiting 50
- Calls
 - Answering 14
 - Clearing 15
 - Diverting 51
 - Make 15
 - Making 28
 - Parking 20
- Changing
 - Your Greeting 32
 - Your Mailbox Password 34

- Chart
 - Troubleshooting 61

- Clearing
 - Call 15
- Conference 19
- Contrast Control 37

D

- Data
 - Entering 58
- Default Short Codes 53
- Deleting
 - all Entries 28
 - Individual Log Entry 28
 - Speed Dial 23
- Dialling
 - Speed Dial Number 23
- Disabling
 - Call Log 28
- Display 10, 60
 - Individual Log Entry 27
- Display Call Timers 41
- Display Language Selection 39
- Diverting
 - Calls 51

E

- Editing
 - Speed Dial 23
- Email Alerts 33
- Entering
 - Data 58
- EXITing
 - Call Log 28

- External WAP Websites
 - Accessing 57

F

- Feature Button Labeling 38
- Function Key Programming 45

H

- Headset Working 16
- Hold 17

I

- Individual Log Entry
 - Displaying 27
- Individual Log Entry
 - Deleting 28

L

- Listen
 - Voicemails 31
- Log 28
 - Off 11
 - On 11
- Log Entry into
 - Turning 28
- Longhand Programming Mode 48

M

- Making
 - Call 15
 - Calls 28
- Message Display Rate 41
- Mute 17

N

- New Speed Dial
 - Adding 24
- Not Disturb 52

O

- Off
 - Logging 11
- On
 - Logging 11
- Overview 7, 22, 26, 44, 56, 60
 - Visual Voice 30

P

- Parking
 - Calls 20
- Personal Ringing Options 36
- Phone
 - Reinstating 37
- Phone Screen on Answer 40
- Phone Screen on Calling 40
- Private Call 20

R

- Redial 18
- Reinstating
 - Phone 37

S

- Send
 - Voicemail 33
- Shorthand Programming Mode 47
- Speakerphone 17
- Speed Dial 18, 28
 - Adding 23
 - Deleting 23
 - Editing 23
- Speed Dial Number
 - Dialling 23

T

Telephone's Lights

Testing 60

Testing

Telephone's Lights 60

Transfer 18

Troubleshooting

Chart 61

Turning

Log Entry into 28

U

User 12

V

View IP Settings 36

Visual Alerting 41

Visual Voice

Overview 30

Voicemail 52

Send 33

Voicemail TRANSFER 34

Voicemails

Listen 31

W

Web Navigation Controls 57

Y

Your Greeting

Changing 32

Your Mailbox Password

Changing 34

Performance figures and data quoted in this document are typical, and must be specifically confirmed in writing by Avaya before they become applicable to any particular order or contract. The company reserves the right to make alterations or amendments to the detailed specifications at its discretion. The publication of information in this document does not imply freedom from patent or other protective rights of Avaya or others.

Intellectual property related to this product (including trademarks) and registered to Lucent Technologies have been transferred or licensed to Avaya.

All trademarks identified by the ® or ™ are registered trademarks or trademarks, respectively, of Avaya Inc. All other trademarks are the property of their respective owners.

This document contains proprietary information of Avaya and is not to be disclosed or used except in accordance with applicable agreements.

Any comments or suggestions regarding this document should be sent to "wgctechpubs@avaya.com".

© 2009 Avaya Inc. All rights reserved.

Avaya
Unit 1, Sterling Court
15 - 21 Mundells
Welwyn Garden City
Hertfordshire
AL7 1LZ
England.

Tel: +44 (0) 1707 392200
Fax: +44 (0) 1707 376933

Web: <http://marketingtools.avaya.com/knowledgebase>